

## 1. Introduction

This external box can provide communication slot for UPS or inverter without intelligent slot. This external box is perfect for Modbus, SNMP or GPRS communication card. Simply insert the demanded communication card into this external box and follow wire connection according to user manual of communication card. Then, it provides proper communication for UPSs and inverters.

## 2. Unpacking & Overview

### 2-1. Packing List

Before installation, please inspect the unit. Be sure that nothing inside the package is damaged. You should have received the following items inside of package:

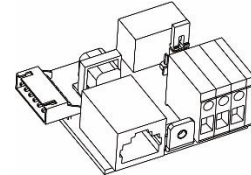
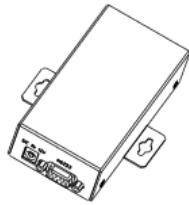

DB9-RJ45 cable

RJ45 communication board  
(only require for inverter 1-3K model)

### 2-2. Product Overview

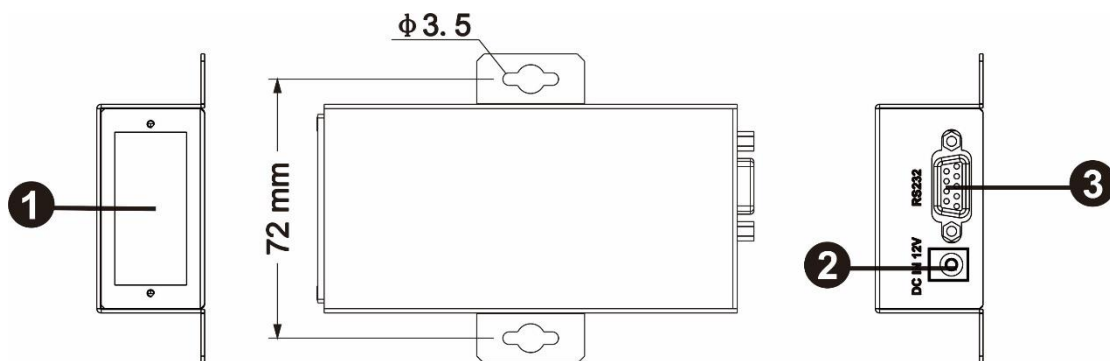

1. Communication card intelligent slot
2. 12V DC input : 12V DC/1A power source for communication card
3. RS-232 communication port

### 3. Connection

#### UPS or Inverter with RJ45 port

Adapter  
100~240Vac / 12Vdc 1A

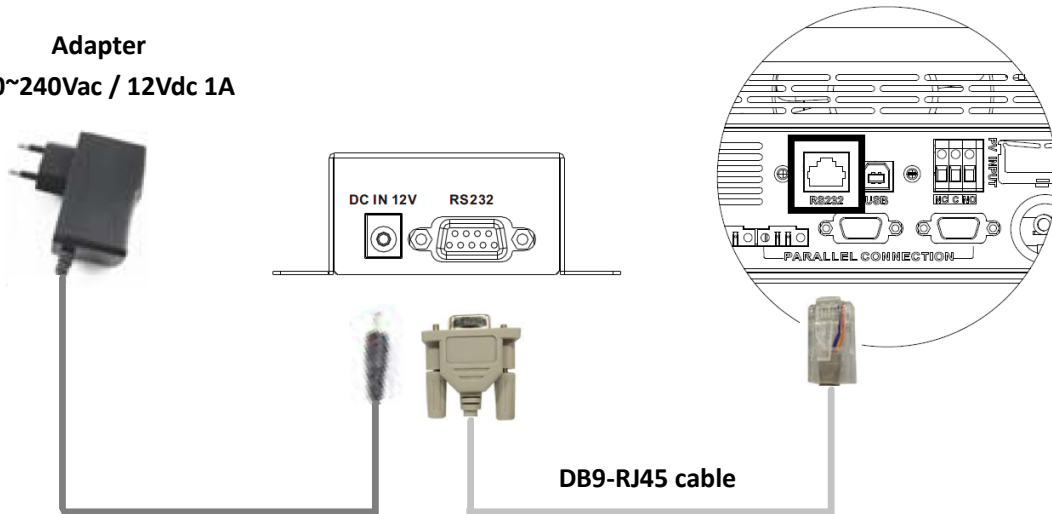

**NOTE:** It's not necessary to use adapter for 4KVA//5KVA inverter.

#### UPS or Inverter with DB9 port

Adapter  
100~240Vac / 12Vdc 1A

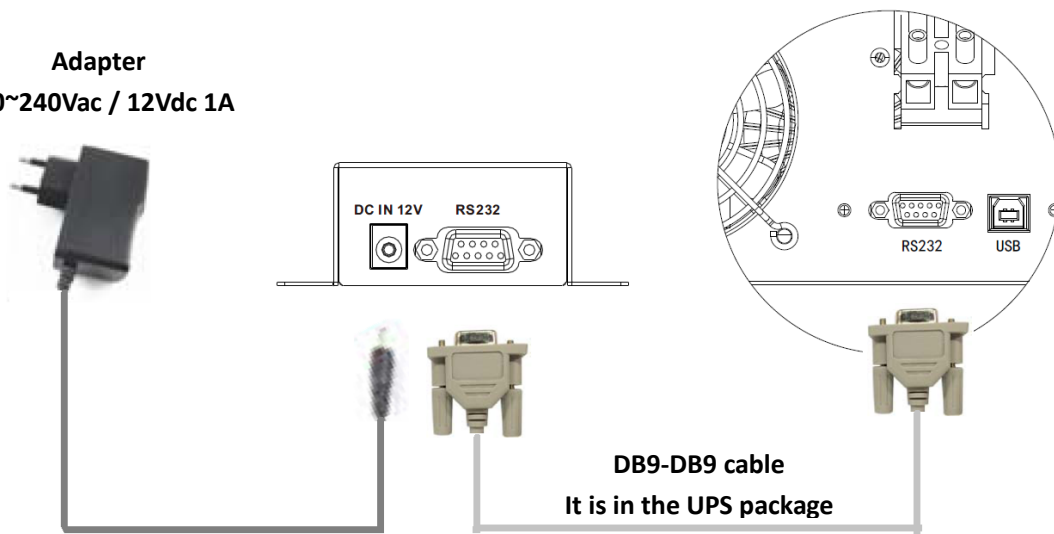

Adapter plug dimension: OD=5.5mm ID=2.5mm



### Inverter with USB port

If connecting to inverter with only USB port, please replace the communication board in the inverter with bundled communication port. Then, follow the same step in previous section to connect to External Box.

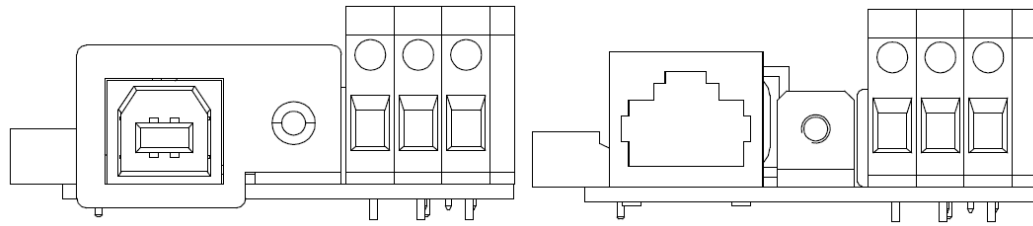

USB communication board

RJ45 communication board

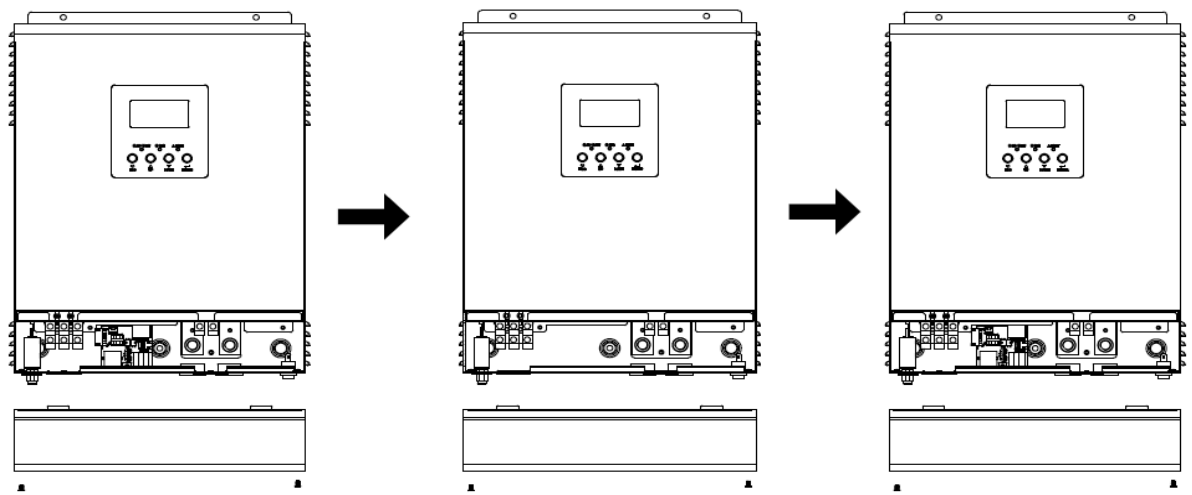

**Step 1:** Remove terminal cover.

**Step 2:** Remove USB communication board.

**Step 3:** Put bundled RJ45 communication board in same place.

## 4. Quick Assembly

**Step 1:** Simply insert communication card into the one side of external box.  
Then, screw it tightly as shown in below chart.

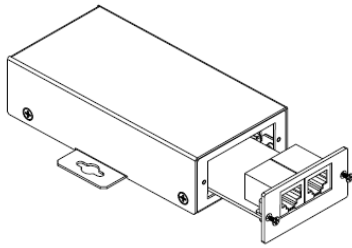

Modbus card

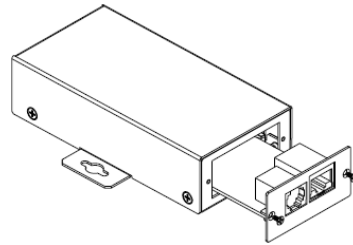

SNMP card

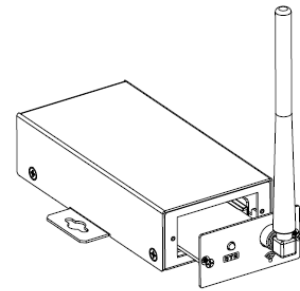

GPRS card

**Step 2:** Please follow user manual of communication card for wire connection.